

E3M-V

Great for Irregularities and Lamination, an Easy-to-use Mark Sensor





 Be sure to read *Safety Precautions* on page 5.

Ordering Information

Sensors



 Green

Appearance	Connection method	Sensing distance	Spot diameter	Model	
				NPN output	PNP output
	Connector (M12)*	 10 ± 3 mm	1 × 4 mm	E3M-VG11	E3M-VG16
			4 × 1 mm	E3M-VG21	E3M-VG26



* Switchable between vertical and horizontal directions with a rotation connector.

Accessories (Order Separately)

Mounting Brackets

Appearance	Model	Quantity	Remarks
	E39-L131	1	---
	E39-L132	1	For rear mounting

Sensor I/O Connectors

Cable	Appearance	Cable type	Model
Standard	Straight 	2 m	XS2F-D421-D80-A
		5 m	XS2F-D421-G80-A
	L-shaped 	2 m	XS2F-D422-D80-A
		5 m	XS2F-D422-G80-A

Ratings and Specifications

Item	Model	E3M-VG11	E3M-VG21	E3M-VG16	E3M-VG26
Sensing distance		10 ± 3 mm			
Spot size (horizontal × vertical)		1 × 4 mm	4 × 1 mm	1 × 4 mm	4 × 1 mm
Light source (wavelength)		Green LED (525 nm)			
Power supply voltage		10 to 30 VDC including 10% (p.p) ripple			
Current consumption		100 mA max.			
Control output		Load power supply voltage: 30 VDC max., Load current: 100 mA max. (Residual voltage: 1.2 V max.), NPN open collector output		Load power supply voltage: 30 VDC max., Load current: 100 mA max. (Residual voltage: 2 V max.), PNP open collector output	
Remote control input *1		ON: Short-circuit to 0 V or 1.5 V max. (Outflow current 1 mA max.) OFF: Open or Vcc-1.5 V to Vcc (Leakage current 0.1 mA max.)		ON: Vcc-1.5 V to Vcc (Inlet current 3 mA max.) OFF: Open or 1.5 V max. (Leakage current 0.1 mA max.)	
Remote control output *1		Load power supply voltage: 30 VDC max., Load current: 100 mA max. (Residual voltage: 1.2 V max.), NPN open collector output		Load power supply voltage: 30 VDC max., Load current: 100 mA max. (Residual voltage: 2 V max.), PNP open collector output	
Bank selection		2-bank selection (Performed by remote control only. Refer to the remote control function for details.)			
Protective circuits		Power supply reverse polarity protection, Load short-circuit protection			
Response time		ON: 50 μs max., OFF: 70 μs max.			
Sensitivity adjustment		Teaching system			
Ambient illumination (Receiver side)		Incandescent lamp: 3,000 lx max., Sunlight 10,000 lx max.			
Ambient temperature range		Operating: -20 to 55°C, Storage: -30 to 70°C (with no icing)			
Ambient humidity range		Operating: 35% to 85%, Storage: 35% to 95% (with no condensation)			
Insulation resistance		20 MΩmin. at 500 VDC			
Dielectric strength		1,000 VAC, 50/60 Hz for 1 min			
Vibration resistance *2		Destruction: 10 to 55 Hz, 1-mm double amplitude or 150 m/s ² for 2 hours each in X, Y and Z directions			
Shock resistance *3		Destruction: 500 m/s ² 3 times each in X, Y and Z directions			
Degree of protection		IEC 60529 IP67 (with Protective Cover attached)			
Connection method		M12 Connector			
Weight (packed state)		Approx. 100 g			
Material	Case	PBT (polybutylene terephthalate)			
	Lens	Mechacrylic resin			
Accessories		Instruction manual			

*1. A single cable is shared for remote control input and answer-back output.

*2. 0.75-mm double amplitude or 100 m/s² when using a Mounting Bracket.

*3. 300 m/s² when using a Mounting Bracket.

Engineering Data (Typical)

Sensing Distance vs Incident Level Characteristics

E3M-VG1 □

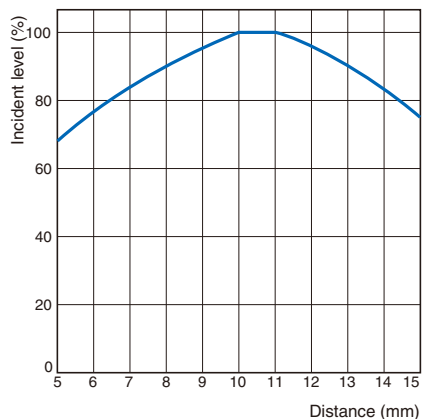

Angle - Incident Level Characteristics (X Direction)

E3M-VG1 □/-VG2 □

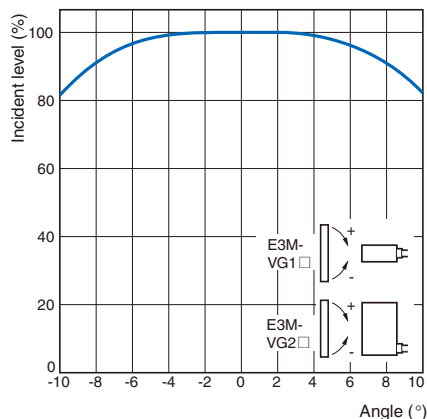

Angle - Incident Level Characteristics (Y Direction)

E3M-VG1 □/-VG2 □

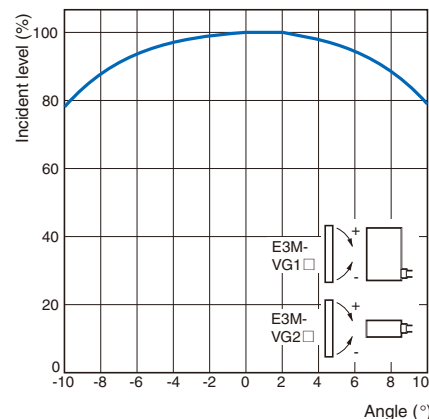

Color Detection

E3M-VG □ □

	White	Red	Yellow/red	Yellow	Yellow/green	Green	Blue/green	Blue	Purple	Red/purple	Black
White	○	○	○	○	○	○	○	○	○	○	○
Red	○	○	○	○	○	○	○	○	○	×	△
Yellow/red	○	○	○	○	○	○	○	○	×	○	○
Yellow	○	○	○	○	○	○	○	○	○	○	○
Yellow/green	○	○	○	○	○	○	○	○	○	○	○
Green	○	○	○	○	○	○	○	○	○	○	○
Blue/green	○	○	○	○	○	○	○	△	○	○	○
Blue	○	○	○	○	○	○	△	△	○	○	○
Purple	○	○	×	○	○	○	○	△	○	○	○
Red/purple	○	×	○	○	○	○	○	○	○	○	×
Black	○	△	○	○	○	○	○	○	○	×	○

○: Detectable △: Detectable but unstable ×: Not detectable

Difference in Incident Level by Color Conditions

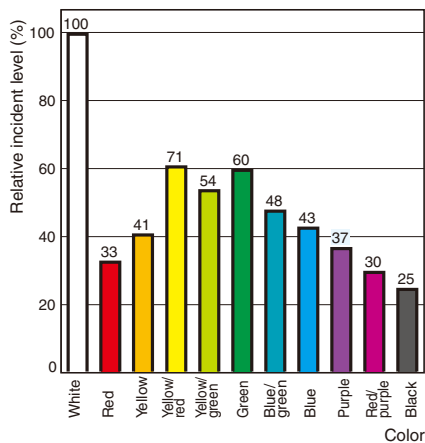

Standard Sensing Object and Colors (Standard Color Card (230 Colors) for Japan Color Enterprise Co., Ltd.)

Color (11 standard colors)	Munsell color notation
White	N9.5
Red	4R 4.5/12.0
Yellow/red	4YR 6.0/11.5
Yellow	5Y 8.5/11.0
Yellow/green	3GY 6.5/10.0
Green	3G 6.5/9.0
Blue/green	5BG 4.5/10.0
Blue	3PB 5.0/10.0
Purple	7P 5.0/10.0
Red/purple	6RP 4.5/12.5
Black	N2.0

I/O Circuit Diagrams

NPN output

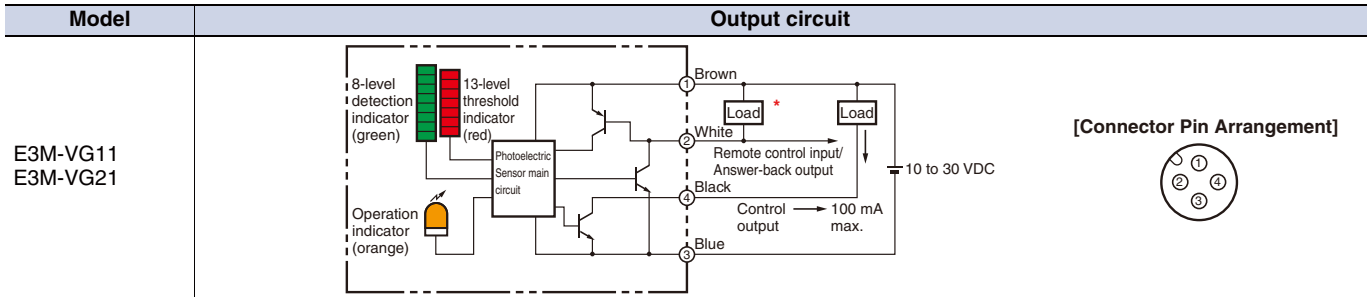

* A single cable is shared for remote control input and answer-back output. Be sure to install a load as shown in the diagram for the remote control function.

PNP output

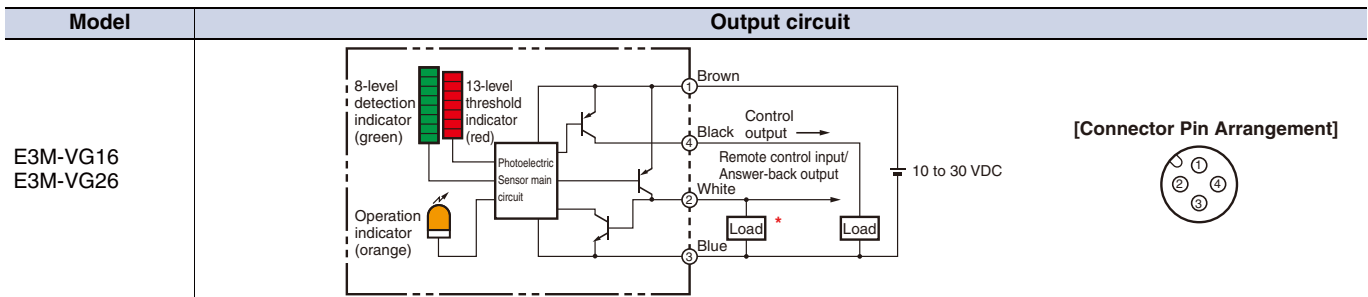

* A single cable is shared for remote control input and answer-back output. Be sure to install a load as shown in the diagram for the remote control function.

Plug (Sensor I/O Connector)

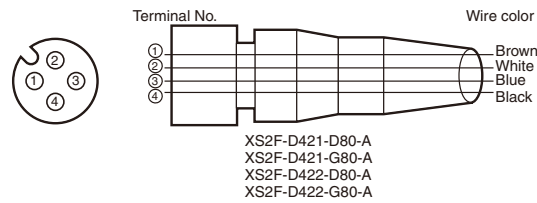

Class	Wire color	Connector pin No.	Application
DC	Brown	1	Power supply (+V)
	White	2	*
	Blue	3	Power supply (0 V)
	Black	4	Output

* Used for both of remote control input and answer-back output

Technical Guide

Detection of Metal or Glossy Objects

Color detection can be improved by inclining the Sensor to prevent it from picking up regular reflection.

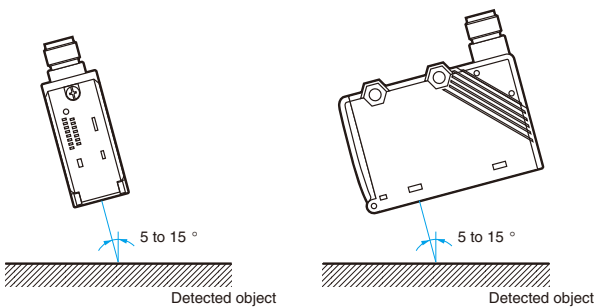

Nomenclature

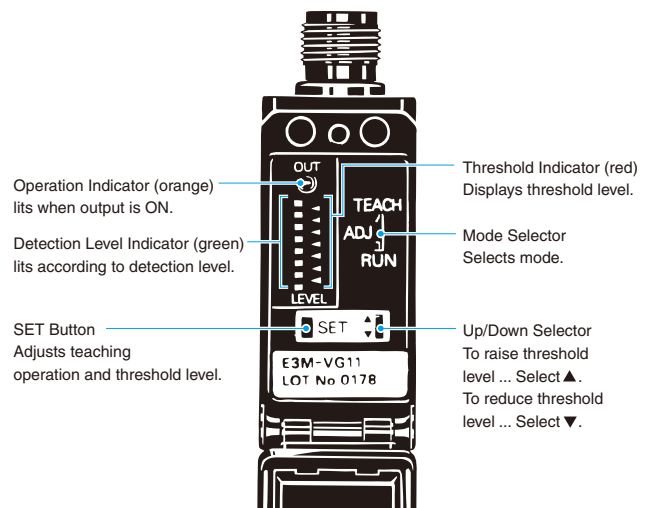

Safety Precautions

Refer to *Warranty and Limitations of Liability*.

 **WARNING**

This product is not designed or rated for ensuring safety of persons either directly or indirectly. Do not use it for such purposes.



Precautions for Correct Use

Do not use the product in atmospheres or environments that exceed product ratings.

● Designing

Power Supply

A power supply with full- or half-wave rectification cannot be connected.

● Wiring

Tensile Strength of Cables

The tensile strength of the cable should not exceed 50 N.

● Mounting

Tightening Force

The tightening force applied to the Fiber Unit should not exceed 1.2 N·m.

Mounting the Sensor

If Sensors are mounted face-to-face, make sure that the optical axes are not in opposition to each other. Otherwise, mutual interference may result.

● Others

EEPROM Writing Error

An EEPROM error may result if the power supply to the Sensor fails or the Sensor is influenced by static noise. The threshold indicators will flash if there is an EEPROM error, in which case perform teaching and make threshold level settings again.

(Unit: mm)

Dimensions

Unless otherwise specified, the tolerance class IT16 is used for dimensions in this data sheet.

Sensors

E3M-VG

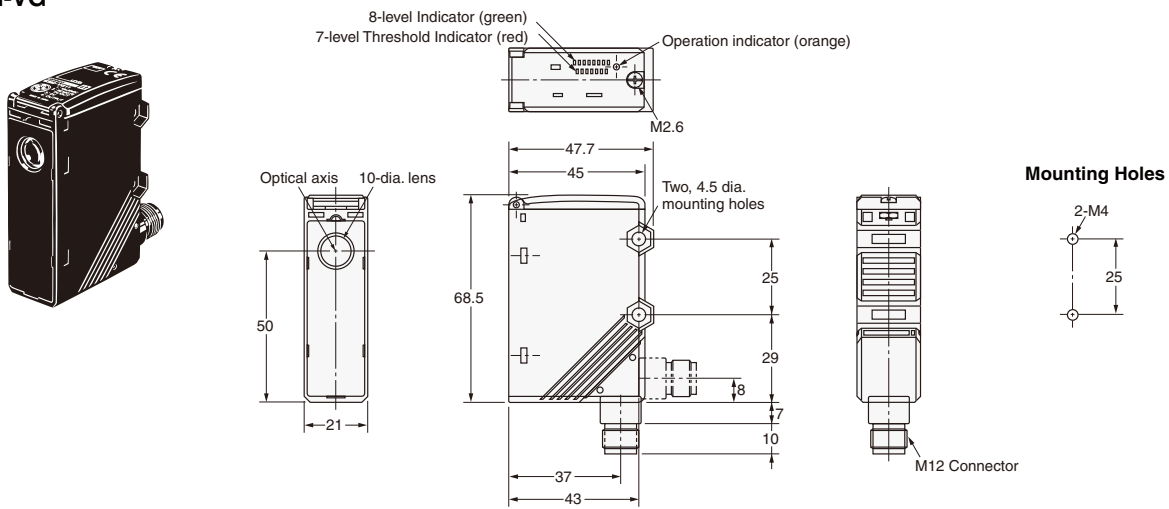

Accessories (Order Separately)

Mounting Brackets

E3M-V

Adjustment Steps

Step	Operation
1	Install, wire, and turn ON the Sensor.
2	Register (i.e., teach) the marks. →Refer to <i>Registering Marks</i> on this page to page 8.
3	Adjust thresholds as required. →Refer to <i>Adjusting Thresholds</i> on page 9.
4	Check that the mode selector switch is set to RUN.

Registering (Teaching) Marks

Select the most appropriate teaching method in reference to the following descriptions.

Application	1	2	3
	Detection of clear color differences between the mark and the background when the background has a color pattern.	Detection of slight color differences between the mark and background when the background has no color pattern.	Remote teaching without positioning when the background has no color pattern.

Teaching method	1	2	1
	One-point teaching	Two-point teaching	Automatic teaching
Output ON range	The default value will be set, and the output will turn ON at the mark.	The threshold will be set in the middle between the mark and the background, and the output will turn ON at the mark.	The threshold will be set in the middle between the mark and the background, and the output will turn ON at the mark (which has the shortest passage time).

Refer to the following descriptions for each teaching method. One-point teaching and two-point teaching can be controlled remotely. →Refer to *Remote Control Function* on page 10.

1 One-point Teaching

Step	Operation method	Operation condition
1	Set the mode selector switch to TEACH.	
2	Place the mark in the specified location, and press the SET Button. The threshold indicators (red) will light.	
3	Set the mode selector switch to RUN. The output will turn ON at the set mark.	

Note: The reverse of the output described above (Background: ON, Mark: OFF) can be obtained by teaching using the background.

2 Two-point Teaching

Step	Operation method	Operation condition
1	Set the mode selector switch to TEACH.	
2	Place the mark in the specified location, and press the SET Button. The threshold indicators (red) will light.	

Continued on next page

Step	Operation method	Operation condition
3	<p>If the teaching is OK, move the mark and press the SET button when the mark is at the position of the background.</p> <ul style="list-style-type: none"> If the teaching is OK, the detection level indicators (green) will all be lit. If the teaching fails, the threshold indicators (red) will all flash. 	
4	<p>If the teaching is OK, the setting will be completed.</p> <p>Set the mode selector switch to RUN.</p> <p>If the teaching fails, perform the setting again from step 2.</p>	

Note: These teaching steps are for turning output ON at the mark. The output can be set to turn On at the background and turn OFF at the mark by reversing the order of teaching.

3 Automatic Teaching

Step	Operation
1	Check that the mode selector switch is set to either RUN or ADJUST.
2	A pulse of 0.9 s (see note) will be input to the remote control input/output.
3	<p>Teaching will be performed automatically when the mark is moved. (Teaching will be completed after the mark passes six times.)</p> <ul style="list-style-type: none"> If teaching is OK, answer-back of 0.3 s will be output from the remote control input/output. If teaching fails, answer-back will not be output. In this case, perform the adjustment again using two-point teaching. (Teaching will not be OK if there is no difference in light levels between the mark and the background.)
4	If answer-back is detected, the setting will be completed. <u>The output will turn ON at the mark (which has the shortest passage time), and measurement will start.</u>

Note: Set input error of each signal pulse to within ± 0.1 s.

Automatic Teaching

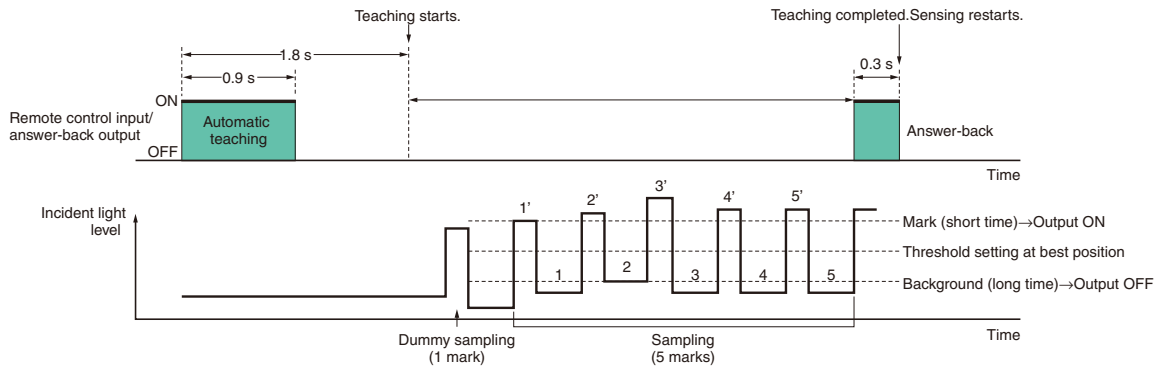

Example of Connection with Programmable Controller

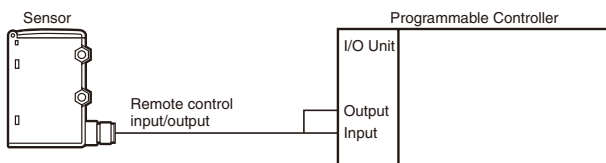

Note: Connect the Sensor as shown in the figure above when connecting it to a Programmable Controller.

Precautions for Using Automatic Teaching

In the following application conditions, incorrect judgment may occur using automatic tuning. If this occurs, use one-point teaching or two-point teaching.

- The background has a color pattern.
- There is a lot of variation in the samples.
- The surface has height differences or protrusions.

Adjusting Thresholds

Fine adjustment of thresholds can be performed after teaching. Operation can be performed remotely.

→ Refer to **Remote Control Function** on the next page.

Step	Operation method	Operation condition																												
1	Set the mode selector switch to ADJUST.																													
2	In the ADJUST mode, specify the direction of adjustment using the Up/Down selector switch. The threshold will transition each time the SET Button is pressed. (Two indicators will be lit at the same time for even-numbered threshold levels.)	<table border="1"> <thead> <tr> <th>Threshold indicators</th> <td>▲▲▲▲▲▲▲</td> <td>▲▲▲▲▲▲▲</td> <td>▲▲▲▲▲▲▲</td> <td>▲▲▲▲▲▲▲</td> <td>▲▲▲▲▲▲▲</td> <td>▲▲▲▲▲▲▲</td> <td>▲▲▲▲▲▲▲</td> <td>▲▲▲▲▲▲▲</td> <td>▲▲▲▲▲▲▲</td> <td>▲▲▲▲▲▲▲</td> <td>▲▲▲▲▲▲▲</td> <td>▲▲▲▲▲▲▲</td> <td>▲▲▲▲▲▲▲</td> </tr> <tr> <th>Threshold</th> <td>1</td> <td>2</td> <td>3</td> <td>4</td> <td>5</td> <td>6</td> <td>7</td> <td>8</td> <td>9</td> <td>10</td> <td>11</td> <td>12</td> <td>13</td> </tr> </thead></table>	Threshold indicators	▲▲▲▲▲▲▲	▲▲▲▲▲▲▲	▲▲▲▲▲▲▲	▲▲▲▲▲▲▲	▲▲▲▲▲▲▲	▲▲▲▲▲▲▲	▲▲▲▲▲▲▲	▲▲▲▲▲▲▲	▲▲▲▲▲▲▲	▲▲▲▲▲▲▲	▲▲▲▲▲▲▲	▲▲▲▲▲▲▲	▲▲▲▲▲▲▲	Threshold	1	2	3	4	5	6	7	8	9	10	11	12	13
Threshold indicators	▲▲▲▲▲▲▲	▲▲▲▲▲▲▲	▲▲▲▲▲▲▲	▲▲▲▲▲▲▲	▲▲▲▲▲▲▲	▲▲▲▲▲▲▲	▲▲▲▲▲▲▲	▲▲▲▲▲▲▲	▲▲▲▲▲▲▲	▲▲▲▲▲▲▲	▲▲▲▲▲▲▲	▲▲▲▲▲▲▲	▲▲▲▲▲▲▲																	
Threshold	1	2	3	4	5	6	7	8	9	10	11	12	13																	
3	After the setting is completed, set the mode selector switch to RUN.																													

Detection Level Indicators

The control output will turn ON if the detection level exceeds the threshold level. The detection level display will depend on the teaching method.

One-point Teaching

Two thresholds (i.e., above and below the mark) are set. The indicators show the degree of match with the mark.

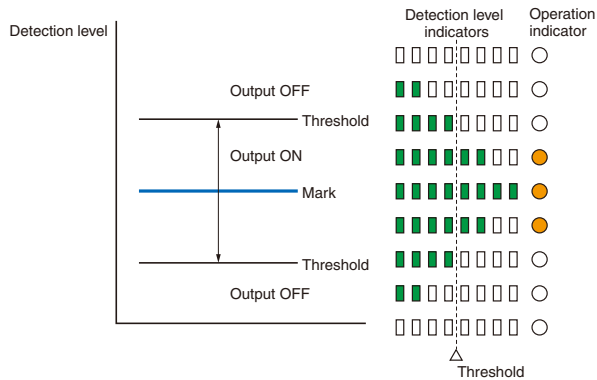

Two-point teaching and Automatic Teaching

A threshold is set in the middle between the mark (first registration) and background (second registration). The indicators show the level of excess gain between the mark and the background.

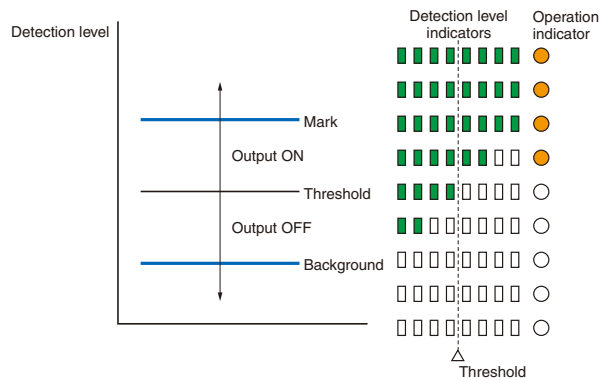

Remote Control Function (Bank Selection, Mark Registration, Threshold Adjustment)

In RUN mode and ADJUST mode, remote operation can be performed by inputting the signals in the following table for the remote control input/answer-back output. There will be answer-back output for 0.3 s if the signal is correctly received.

Only one-point teaching can also be operated with manual input.
(Provide input for 1.5 s min.)

Timing Chart

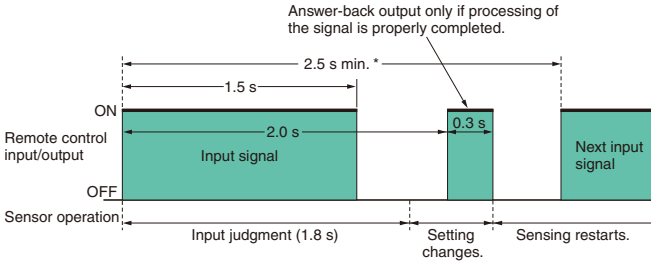

*If consecutive signals are to be sent, allow an interval of at least 2.5 s after the signal is input, as in the figure above.

Example of Ladder Programming

Control signals can be created using the example of ladder programming shown in the following figure.

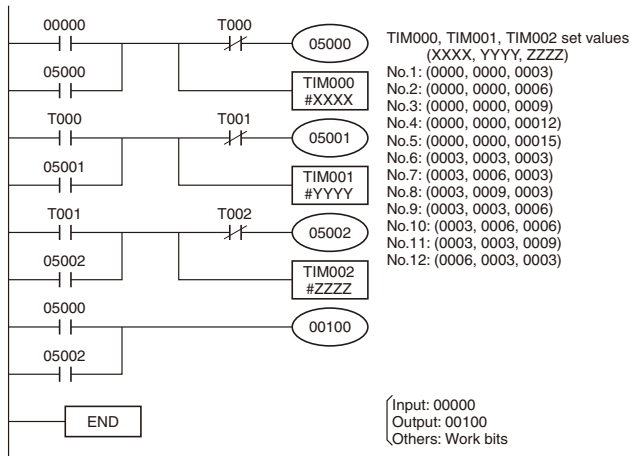

Control Signals

No.	Control signal	Function
1	ON pulse of 0.3 s	Bank 1 selection (Operation indicator OFF in TEACH mode)
2	ON pulse of 0.6 s	Bank 2 selection (Operation indicator lit in TEACH mode)
3	ON pulse of 0.9 s	Automatic teaching
4	ON pulse of 1.2 s	Two-point teaching (first and second)
5	ON pulse of 1.5 s min.	One-point teaching (input of 1.5 s min. also possible)
6	Three ON pulses of 0.3 s each	Threshold 1 selection
7	Three ON pulses: 0.3 s, 0.6 s, 0.3 s	Threshold 3 selection
8	Three ON pulses: 0.3 s, 0.9 s, 0.3 s	Threshold 5 selection
9	Three ON pulses: 0.3 s, 0.6 s, 0.6 s	Threshold 7 selection
10	Three ON pulses: 0.3 s, 0.6 s, 0.6 s	Threshold 9 selection
11	Three ON pulses: 0.3 s, 0.9 s, 0.3 s	Threshold 11 selection
12	Three ON pulses: 0.6 s, 0.3 s, 0.3 s	Threshold 13 selection

Note: Set input error of each signal pulse to within ± 0.1 s

Photoelectric Sensors Technical Guide

General Precautions

For precautions on individual products, refer to *Safety Precautions* in individual product information.

⚠ WARNING

These Sensors cannot be used in safety devices for presses or other safety devices used to protect human life. These Sensors are designed for use in applications for sensing workpieces and workers that do not affect safety.



Precautions for Safe Use

To ensure safety, always observe the following precautions.

● Wiring

Item	Typical examples	
<p>Power Supply Voltage</p> <p>Do not use a voltage in excess of the operating voltage range. Applying a voltage in excess of the operating voltage range, or applying AC power (100 VAC or greater) to a DC Sensor may cause explosion or burning.</p>	<p>• DC Three-wire NPN Output Sensors</p>	---
<p>Load Short-circuiting</p> <p>Do not short-circuit the load. Doing so may cause explosion or burning.</p>	<p>• DC Three-wire NPN Output Sensor</p>	<p>• AC Two-wire Sensors Example: E3E2</p>
<p>Incorrect Wiring</p> <p>Do not reverse the power supply polarity or otherwise wire incorrectly. Doing so may cause explosion or burning.</p>	<p>• DC Three-wire NPN Output Sensors Example: Incorrect Polarity</p>	<p>• DC Three-wire NPN Output Sensors Example: Incorrect Polarity Wiring</p>
<p>Connection without a load</p> <p>If the power supply is connected directly without a load, the internal elements may burst or burn. Be sure to insert a load when connecting the power supply.</p>	<p>• DC Three-wire NPN Output Sensors</p>	<p>• AC 2-wire Sensors Example: E3E2 etc.</p>

● Operating Environment

- (1) Do not use a Sensor in an environment where there are explosive or inflammable gases.
- (2) Do not use the Sensor in environments where the cables may become immersed in oil or other liquids or where liquids may penetrate the Sensor. Doing so may result in damage from burning and fire, particularly if the liquid is flammable.

Precautions for Correct Use

● Design

Power Reset Time

The Sensor will be ready to detect within approximately 100 ms after the power is turned ON.

If the Sensor and the load are connected to separate power supplies, turn ON the Sensor power before turning ON the load power. Any exceptions to this rule are indicated in *Safety Precautions* in individual product information.

Turning OFF Power

An output pulse may be generated when the power is turned OFF. It is recommended that the load or load line power be turned OFF before the Sensor power is turned OFF.

Power Supply Types

An unsmoothed full-wave or half-wave rectifying power supply cannot be used.

Mutual Interference

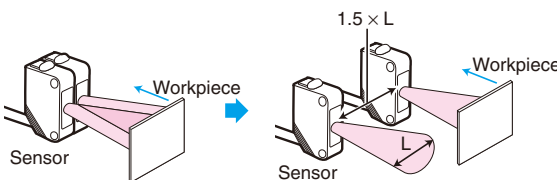
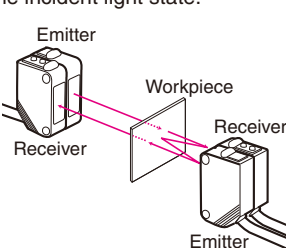
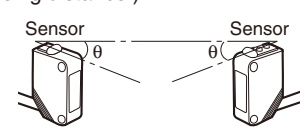

Mutual interference is a state where an output is unstable because the Sensors are affected by light from the adjacent Sensors. The following measures can be taken to avoid mutual interference.

Counter-measure	Concept	Through-beam Sensors	Reflective Sensors
1	Use a Sensor with the interference prevention function.	If Sensors are mounted in close proximity, use Sensors with the interference prevention function. 10 or fewer Sensors: E3X-DA□-S, E3X-MDA, E3C-LDA Fiber Sensors Performance, however, will depend on conditions. Refer to pages E3X-DA-S/E3X-MDA and E3C-LDA. 5 or fewer Sensors: E3X-NA Fiber Sensors 2 or fewer Sensors: E3T, E3Z, E3ZM, E3ZM-C, E3S-C, E3G-L1/L3, or E3S-C Built-in Amplifier Photoelectric Sensors (except Through-beam Sensors) E3C Photoelectric Sensor with separate amplifier	
2	Install an inference prevention filter.	A mutual interference prevention polarizing filter can be installed on only the E3Z-TA to allow close-proximity mounting of up to 2 Sensors. Mutual Interference Prevention Polarizing Filter: E39-E11	---
3	Separate Sensors to distance where interference does not occur.	Check the parallel movement distance range in the catalog, verify the set distance between adjacent Sensors, and install the Sensors accordingly at a distance at least 1.5 times the parallel movement distance range.	If the workpieces move from far to near, chattering may occur in the vicinity of the operating point. For this type of application, separate the Sensors by at least 1.5 times the operating range. 
4	Alternate Emitters and Receivers.	Close mounting of Sensors is possible by alternating the Emitters with the Receivers in a zigzag fashion (up to two Sensors). However, if the workpieces are close to the Photoelectric Sensors, light from the adjacent Emitter may be received and cause the Sensor to change to the incident light state. 	---
5	Offset the optical axes.	If there is a possibility that light from another Sensor may enter the Receiver, change the position of the Emitter and Receiver, place a light barrier between the Sensors, or take other measures to prevent the light from entering the Receiver. (Light may enter even if the Sensors are separated by more than the sensing distance.)	If Sensors are mounted in opposite each other, slant the Sensors as shown in the following diagram. (This is because the Sensors may affect each other and cause output chattering even if separated by more than the Sensor sensing distance.) 
6	Adjust the sensitivity.	Lowering the sensitivity will generally help.	

Photoelectric Sensors Technical Guide

Noise

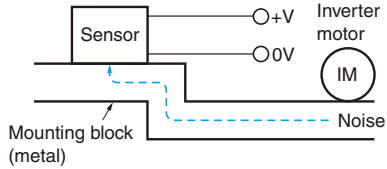
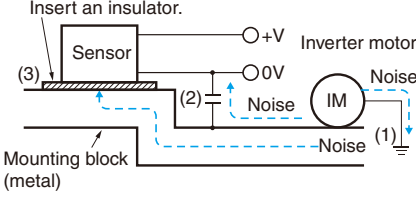
Countermeasures for noise depend on the path of noise entry, frequency components, and wave heights. Typical measures are as given in the following table.

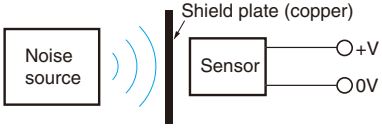
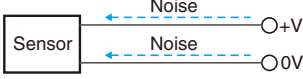
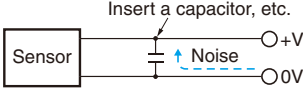
Type of noise	Noise intrusion path and countermeasure	
	Before countermeasure	After countermeasure
Common mode noise (inverter noise) (Common noise applied between the mounting board and the +V and 0-V lines, respectively.)	Noise enters from the noise source through the frame (metal). 	<ol style="list-style-type: none"> Ground the inverter motor (to 100 Ω or less) Ground the noise source and the power supply (0-V side) through a capacitor (film capacitor, 0.22 μF, 630 V). Insert an insulator (plastic, rubber, etc.) between the Sensor and the mounting plate (metal). 
Radiant noise (Ingress of high-frequency electromagnetic waves directly into Sensor, from power line, etc.)	Noise propagates through the air from the noise source and directly enters the Sensor. 	<ul style="list-style-type: none"> Insert a shield (copper) plate between the Sensor and the noise source e.g., a switching power supply). Separate the noise source and the Sensor to a distance where noise does not affect operation. 
Power line noise (Ingress of electromagnetic induction from high-voltage wires and switching noise from the switching power supply)	Noise enters from the power line. 	<ul style="list-style-type: none"> Insert a capacitor (e.g., a film capacitor), noise filter (e.g., ferrite core or insulated transformer), or varistor in the power line. 

● Wiring

Cable

Unless otherwise indicated, the maximum length of cable extension is 100 m using wire that is 0.3 mm² or greater.

Exceptions are indicated in **Safety Precautions** in individual product information.

Cable Tensile Strength

When wiring the cable, do not subject the cable to a tension greater than that indicated in the following table.

Cable diameter	Tensile strength
Less than 4 mm	30 N max.
4 mm or greater	50 N max.

Note: Do not subject a shielded cable or coaxial cable to tension.

Repeated Bending

Normally, the Sensor cable should not be bent repeatedly. (For bending-resistant cable, see **Attachment to Moving Parts** on page C-4.)

Separation from High Voltage (Wiring Method)

Do not lay the cables for the Sensor together with high-voltage lines or power lines. Placing them in the same conduit or duct may cause damage or malfunction due to induction interference. As a general rule, wire the Sensor in a separate system, use an independent metal conduit, or use shielded cable.

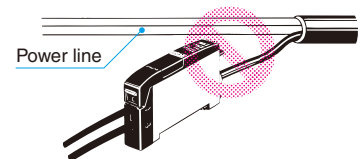

Work Required for Unconnected Leads

Unused leads for self-diagnosis outputs or other special functions should be cut and wrapped with insulating tape to prevent contact with other terminals.

Power Supply

When using a commercially available switching regulator, ground the FG (frame ground) and G (ground) terminals. If not grounded, switching noise in the power supply may cause malfunction.

Example of Connection with S3D2 Sensor Controller

DC Three-wire NPN Output Sensors

Reverse operation is possible using the signal input switch on the S3D2.

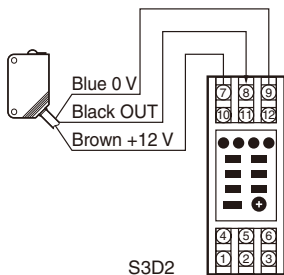

● Mounting

Attachment to Moving Parts

To mount the Photoelectric Sensor to a moving part, such as a robot hand, consider using a Sensors that uses a bending-resistant cable (robot cable).

Although the bending repetition tolerance of a standard cable is approximately 13,000 times, robot cable has an excellent bending tolerance of approximately 500,000 times.

Cable Bending Destruction Test (Tough Wire Breaking Test)

With current flowing, bending is repeated to check the number of bends until the current stops.

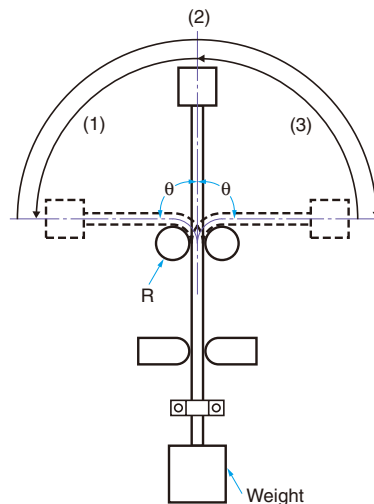

Specimen		Standard cable VR (H) 3 x18/0.12	Robot cable: Strong, conductive electrical wire 2 x 0.15 mm ² , shielded
Description/conditions	Bending angle (θ)	Left/right 90° each	Left/right 45° each
	Bending repetitions	---	60 bends/minute
	Weight	300g	200g
	Operation per bending	(1) through (3) in figure once	(1) through (3) in figure once
	Bending radius of support points (R)	5 mm	2.5 mm
Result		Approx. 13,000 times	Approx. 500,000 times

The testing conditions of the standard cable and robot cable are different.

Refer to the values in the above table to check bend-resistant performance under actual working conditions.

Securing Fibers

The E3X Fiber Unit uses a one-touch locking mechanism. Use the following methods to attach and remove Fiber Units.

(1) Attaching Fibers

Open the protective cover, insert the fiber up to the insertion mark on the side of the Fiber Unit, and then lower the lock lever.

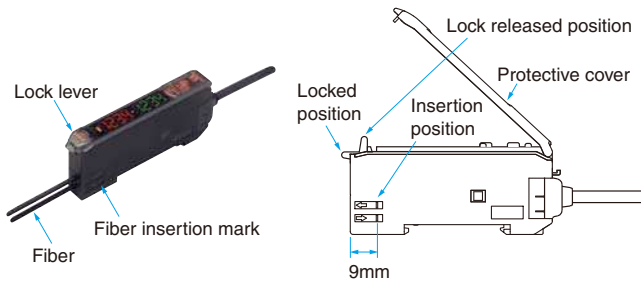

(2) Removing Fibers

Open the protective cover, lift up the lock lever, and pull out the fibers.

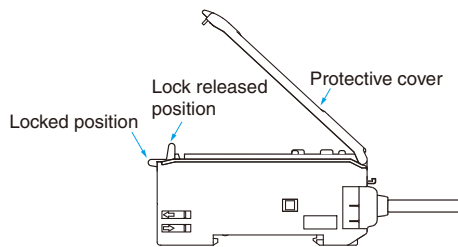

Note: 1. To maintain the fiber characteristics, make sure that the lock is released before removing the fibers.
2. Lock and unlock the fibers at an ambient temperature of -10 to 40°C .

Adjustments

Optical Axis Adjustment

Move the Photoelectric Sensor both vertically and horizontally and set it in the center of the range in which the operation indicator is lit or not lit. For the E3S-C, the optical axis and the mechanical axis are the same, so the optical axis can be easily adjusted by aligning the mechanical axis.

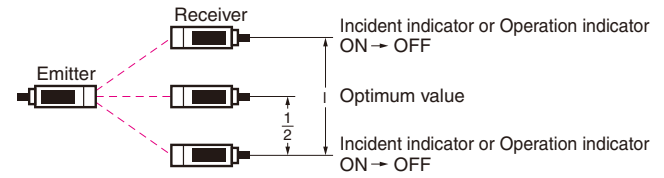

Optical axis: The axis from the center of the lens to the center of the beam for the Emitter and the axis from the center of the lens to the center of the reception area for the Receiver.

Mechanical axis: The axis perpendicular to the center of the lens.

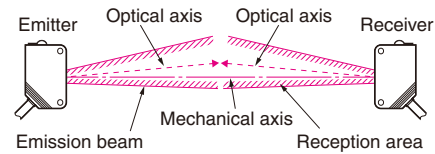

● Operating Environment

Water Resistance

Do not use in water, in rain, or outside.

Ambient Conditions

Do not use this Sensor in the following locations. Otherwise, it may malfunction or fail.

- (1) Locations exposed to excessive dust and dirt
- (2) Locations exposed to direct sunlight
- (3) Locations with corrosive gas vapors
- (4) Locations where organic solvents may splash onto the Sensor
- (5) Locations subject to vibration or shock
- (6) Locations where there is a possibility of direct contact with water, oil, or chemicals
- (7) Locations with high humidity and where condensation may result

Environmentally Resistive Sensors

The E32-T11F/T12F/T14F/T81F-S/D12F/D82F and E3HQ can be used in locations (3) and (6) above.

Optical Fiber Photoelectric Sensors in Explosive Gas Atmospheres

The Fiber Unit can be installed in the hazardous area, and the Amplifier Unit can be installed in a non-hazardous area.

<Reason>

For explosion or fire due to electrical equipment to occur, both the hazardous atmosphere and a source of ignition must be in the same location. Optical energy does not act as an ignition source, thus there is no danger of explosion or fire. The lens, case, and fiber covering are made of plastic, so this setup cannot be used if there is a possibility of contact with solvents that will corrode or degrade (e.g., cloud) the plastic.

<Ignition Source>

Electrical sparks or high-temperature parts that have sufficient energy to cause explosion in a hazardous atmosphere are called ignition sources.

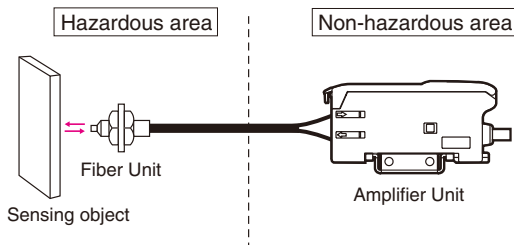

Influence from External Electrical Fields

Do not bring a transceiver near the Photoelectric Sensor or its wiring, because this may cause incorrect operation.

● Maintenance and Inspection

Points to Check When the Sensor Does Not Operate

- If the Sensor does not operate, check the following points.
 - (1) Are the wiring and connections correct?
 - (2) Are any of the mounting screws loose?
 - (3) Are the optical axis and sensitivity adjusted correctly?
 - (4) Do the sensing object and the workpiece speed satisfy the ratings and specifications?
 - (5) Are any foreign objects, such as debris or dust, adhering to the Emitter lens or Receiver lens?
 - (6) Is strong light, such as sunlight (e.g., reflected from a wall), shining on the Receiver?
 - (7) Do not attempt to disassemble or repair the Sensor under any circumstances.
 - (8) If you determine that the Sensor clearly has a failure, immediately turn OFF the power supply.

Lens and Case

The lens and case of the Photoelectric Sensor are primarily made of plastic. Dirt should be gently wiped off with a dry cloth. Do not use thinner or other organic solvents.

- The case of the E3ZM, E3ZM-C and E3S-C is metal. The lens, however, is plastic.

● Accessories

Using a Reflector (E39-R3/R37/RS1/RS2/RS3)

During Application

- (1) When using adhesive tape on the rear face, apply it after washing away oil and dust with detergent. The Reflector cannot be mounted if there is any oil or dirt remaining.
- (2) Do not press on the E39-RS1/RS2/RS3 with metal or a fingernail. This may weaken performance.
- (3) This Sensor cannot be used in locations where oil or chemicals may splash on the Sensor.

M8 and M12 Connectors

- Be sure to connect or disconnect the connector after turning OFF the Sensor.
- Hold the connector cover to connect or disconnect the connector.
- Secure the connector cover by hand. Do not use pliers, otherwise the connector may be damaged.
- If the connector is not connected securely, the connector may be disconnected by vibration or the proper degree of protection of the Sensor may not be maintained.

● Others

Values Given in Typical Examples

The data and values given as typical examples are not ratings and performance and do not indicate specified performance. They are rather values from samples taken from production lots, and are provided for reference as guidelines. Typical examples include the minimum sensing object, engineering data, step (height) detection data, and selection list for specifications.

Cleaning

- Keep organic solvents away from the Sensor. Organic solvents will dissolve the surface.
- Use a soft, dry cloth to clean the Sensor.

Read and Understand This Catalog

Please read and understand this catalog before purchasing the products. Please consult your OMRON representative if you have any questions or comments.

Warranty and Limitations of Liability

WARRANTY

OMRON's exclusive warranty is that the products are free from defects in materials and workmanship for a period of one year (or other period if specified) from date of sale by OMRON.

OMRON MAKES NO WARRANTY OR REPRESENTATION, EXPRESS OR IMPLIED, REGARDING NON-INFRINGEMENT, MERCHANTABILITY, OR FITNESS FOR PARTICULAR PURPOSE OF THE PRODUCTS. ANY BUYER OR USER ACKNOWLEDGES THAT THE BUYER OR USER ALONE HAS DETERMINED THAT THE PRODUCTS WILL SUITABLY MEET THE REQUIREMENTS OF THEIR INTENDED USE. OMRON DISCLAIMS ALL OTHER WARRANTIES, EXPRESS OR IMPLIED.

LIMITATIONS OF LIABILITY

OMRON SHALL NOT BE RESPONSIBLE FOR SPECIAL, INDIRECT, OR CONSEQUENTIAL DAMAGES, LOSS OF PROFITS, OR COMMERCIAL LOSS IN ANY WAY CONNECTED WITH THE PRODUCTS, WHETHER SUCH CLAIM IS BASED ON CONTRACT, WARRANTY, NEGLIGENCE, OR STRICT LIABILITY.

In no event shall responsibility of OMRON for any act exceed the individual price of the product on which liability is asserted.

IN NO EVENT SHALL OMRON BE RESPONSIBLE FOR WARRANTY, REPAIR, OR OTHER CLAIMS REGARDING THE PRODUCTS UNLESS OMRON'S ANALYSIS CONFIRMS THAT THE PRODUCTS WERE PROPERLY HANDLED, STORED, INSTALLED, AND MAINTAINED AND NOT SUBJECT TO CONTAMINATION, ABUSE, MISUSE, OR INAPPROPRIATE MODIFICATION OR REPAIR.

Application Considerations

SUITABILITY FOR USE

OMRON shall not be responsible for conformity with any standards, codes, or regulations that apply to the combination of products in the customer's application or use of the product.

At the customer's request, OMRON will provide applicable third party certification documents identifying ratings and limitations of use that apply to the products. This information by itself is not sufficient for a complete determination of the suitability of the products in combination with the end product, machine, system, or other application or use.

The following are some examples of applications for which particular attention must be given. This is not intended to be an exhaustive list of all possible uses of the products, nor is it intended to imply that the uses listed may be suitable for the products:

- Outdoor use, uses involving potential chemical contamination or electrical interference, or conditions or uses not described in this catalog.
- Nuclear energy control systems, combustion systems, railroad systems, aviation systems, medical equipment, amusement machines, vehicles, safety equipment, and installations subject to separate industry or government regulations.
- Systems, machines, and equipment that could present a risk to life or property.

Please know and observe all prohibitions of use applicable to the products.

NEVER USE THE PRODUCTS FOR AN APPLICATION INVOLVING SERIOUS RISK TO LIFE OR PROPERTY WITHOUT ENSURING THAT THE SYSTEM AS A WHOLE HAS BEEN DESIGNED TO ADDRESS THE RISKS, AND THAT THE OMRON PRODUCT IS PROPERLY RATED AND INSTALLED FOR THE INTENDED USE WITHIN THE OVERALL EQUIPMENT OR SYSTEM.

Disclaimers

CHANGE IN SPECIFICATIONS

Product specifications and accessories may be changed at any time based on improvements and other reasons.

It is our practice to change model numbers when published ratings or features are changed, or when significant construction changes are made. However, some specifications of the product may be changed without any notice. When in doubt, special model numbers may be assigned to fix or establish key specifications for your application on your request. Please consult with your OMRON representative at any time to confirm actual specifications of purchased product.

DIMENSIONS AND WEIGHTS

Dimensions and weights are nominal and are not to be used for manufacturing purposes, even when tolerances are shown.

ERRORS AND OMISSIONS

The information in this catalog has been carefully checked and is believed to be accurate; however, no responsibility is assumed for clerical, typographical, or proofreading errors, or omissions.

PERFORMANCE DATA

Performance data given in this catalog is provided as a guide for the user in determining suitability and does not constitute a warranty. It may represent the result of OMRON's test conditions, and the users must correlate it to actual application requirements. Actual performance is subject to the OMRON Warranty and Limitations of Liability.

PROGRAMMABLE PRODUCTS

OMRON shall not be responsible for the user's programming of a programmable product, or any consequence thereof.

COPYRIGHT AND COPY PERMISSION

This catalog shall not be copied for sales or promotions without permission.

This catalog is protected by copyright and is intended solely for use in conjunction with the product. Please notify us before copying or reproducing this catalog in any manner, for any other purpose. If copying or transmitting this catalog to another, please copy or transmit it in its entirety.



Быстро. Выгодно. Надежно.

Компания Workel занимается комплексными поставками электронных компонентов, со складов Европы, Америки и Азии.

Номенклатура электронных компонентов включает в себя, как активные (микросхемы, транзисторы, тиристоры, диоды), так и пассивные (конденсаторы, трансформаторы, резисторы) элементы, а также датчики, реле, разъемы, переключатели, провода, измерительные приборы, паяльное оборудование и многое другое.

Наши преимущества



Обоснованная цена

Мы предоставляем обоснованную цену на все компоненты, не в ущерб другим параметрам поставляемой продукции



Гарантия качества

Вы можете не переживать за качество заказанных компонентов, поскольку мы тщательно проверяем каждую партию перед отправкой. Никакого риска - в случае форс-мажорной ситуации мы гарантируем 100% возмещение убытков



Скорость доставки

Благодаря собственной отлаженной системе логистики вы получите заказ максимум через 5 -14 дней. Мы доставим его «до двери» в любой регион РФ



Особые условия

Система выстраивания долгосрочных отношений с клиентом позволяет нам выделить постоянную номенклатуру и предложить по ней особые условия поставки



Отличное качество

Система менеджмента качества компании отвечает требованиям ISO 9001:2015

Контакты



+7(495) 308-49-00
(многоканальный)



<http://www.workell.ru>



info@workell.ru